

Working LED lights series M



Input voltage 24 VAC/VDC
Lifespan 50 000 hours
IP65 approved

Working LED light serie M1

Technical specifications:

- Power consumption 9,5 W
- Color range of light 5 500...6 000 K
- Input voltage 24 VAC/VDC
- Operating temperature -20...+45 °C
- Material aluminum, polycarbonate, polyamide + 15 % graphite fibers
- Lifespan 50 000 hours
- IP65 approved



Dimensions in mm:

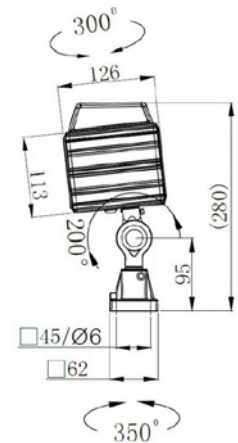

Working LED light serie M1

Type	Power W	Voltage VAC/VDC	EUR/pcs
M1-B1-9,5W-S	9,5	24	85,31

Working LED light serie M1S

Technical specifications:

- Power consumption 9,5 W
- Color range of light 6 000...6 500 K
- Input voltage 24 VAC/VDC
- Operating temperature -20...+45 °C
- Material aluminum, polycarbonate, polyamide + 15 % graphite fibers
- Lifespan 50 000 hours
- IP65 approved



Dimensions in mm:

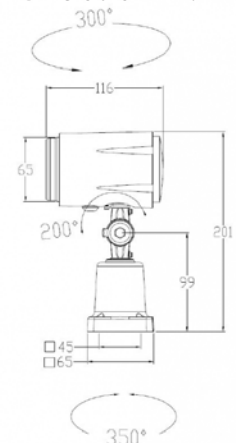

Working LED light serie M1S

Type	Power W	Voltage VAC/VDC	EUR/pcs
M1S-B1-9,5W	9,5	24	82,74

Prices in euros, excl.VAT, non-binding, order discount on request. Subject to errors and technical changes. 10/2024

Working LED light serie M2

Technical specifications:

- Power consumption 9,5 W
- Color range of light 5 500...6 000 K
- Input voltage 24 VAC/VDC
- Operating temperature -20...+45 °C
- Material aluminum, polycarbonate, polyamide + 15 % graphite fibers
- Lifespan 50 000 hours
- IP65 approved

**Length of arm
27 + 19 cm**



Dimensions in mm:

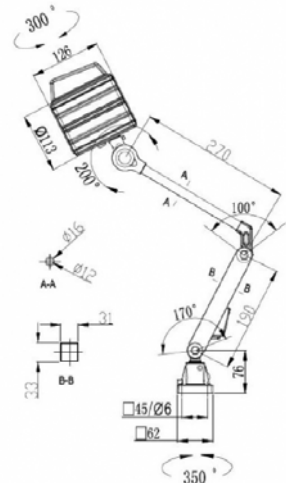

Working LED light serie M2

Type	Power W	Voltage VAC/VDC	EUR/pcs
M2-B1-9,5W-S	9,5	24	103,43

Working LED light serie M2S

Technical specifications:

- Power consumption 9,5 W
- Color range of light 6 000...6 500 K
- Input voltage 24 VAC/VDC
- Operating temperature -20...+45 °C
- Material aluminum, polycarbonate, polyamide + 15 % graphite fibers
- Lifespan 50 000 hours
- IP65 approved

**Length of arm
27 + 19 cm**



Dimensions in mm:

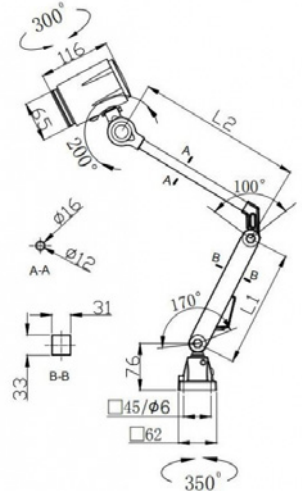

Working LED light serie M2S

Type	Power W	Voltage VAC/VDC	EUR/pcs
M2S-B1-9,5W-S	9,5	24	98,26

Prices in euros, excl.VAT, non-binding, order discount on request. Subject to errors and technical changes. 10/2024

Working LED light serie M3R

Technical specifications:

- Power consumption 4,5 W
- Color range of light 6 000...6 500 K
- Input voltage 24 VAC/VDC
- Operating temperature -20...+45 °C
- Material aluminum, polycarbonate, polyamide + 15 % graphite fibers
- Lifespan 50 000 hours
- IP20 approved

**Magnetic base,
easy install
and remove**



Dimensions in mm:

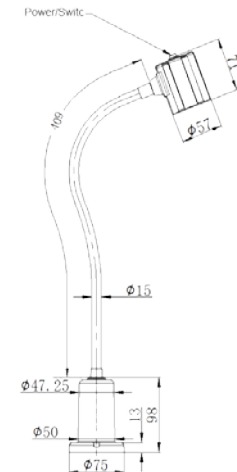

Working LED light serie M3R

Type	Power W	Voltage VAC/VDC	EUR/pcs
M3R-B1-4,5W	4,5	24	67,23

Working LED light serie M3M

Technical specifications:

- Power consumption 4,5 W
- Color range of light 6 000...6 500 K
- Input voltage 24 VAC/VDC
- Operating temperature -20...+45 °C
- Material aluminum, polycarbonate, polyamide
- Lifespan 50 000 hours
- IP54 approved

**Magnetic base,
easy install
and remove**



Dimensions in mm:

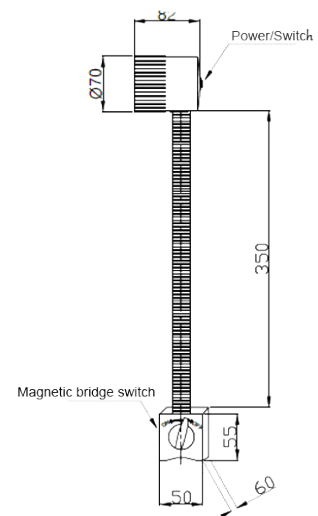

Working LED light serie M3M

Type	Power W	Voltage VAC/VDC	EUR/pcs
M3M-B1-4,5W	4,5	24	72,40

Prices in euros, excl.VAT, non-binding, order discount on request. Subject to errors and technical changes. 10/2024

Working LED light serie M3S

Technical specifications:

- Power consumption 4,5 W
- Color range of light 5 500...6 000 K
- Input voltage 24 VAC/VDC
- Operating temperature -20...+45 °C
- Material aluminum, polycarbonate, polyamide + 15 % graphite fibers
- Lifespan 50 000 hours
- IP20 approved



Dimensions in mm:

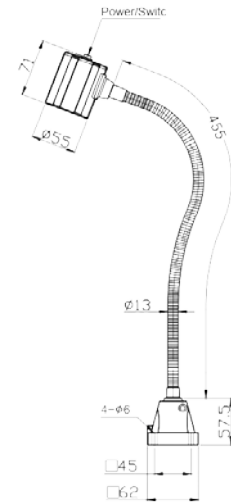

Working LED light serie M3S

Type	Power W	Voltage VAC/VDC	EUR/pcs
M3S-B1-4,5W	4,5	24	41,37

Working LED light serie M3W

Technical specifications:

- Power consumption 4,5 W
- Color range of light 5 500...6 000 K
- Input voltage 24 VAC/VDC
- Operating temperature -20...+45 °C
- Material aluminum, polycarbonate, polyamide
- Lifespan 50 000 hours
- IP65 approved



Dimensions in mm:

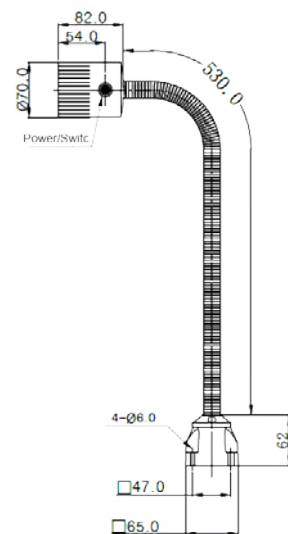

Working LED light serie M3S

Type	Power W	Voltage VAC/VDC	EUR/pcs
M3W-B1-550-4,5W	4,5	24	67,23

Prices in euros, excl.VAT, non-binding, order discount on request. Subject to errors and technical changes. 10/2024